

# Scambiatori di calore

# Dimensionamento

- Trasmissione di calore combinata per conduzione e convezione

$$q = Q/A = -k \, dT/dx$$

$$dq = h(T_p - T_f) dA$$

Combinando le due modalità

$$Q = UA(T_c - T_f)$$

$$U = 1 / (1/h_c + s/k + 1/h_f)$$

# Controcorrente e equicorrente

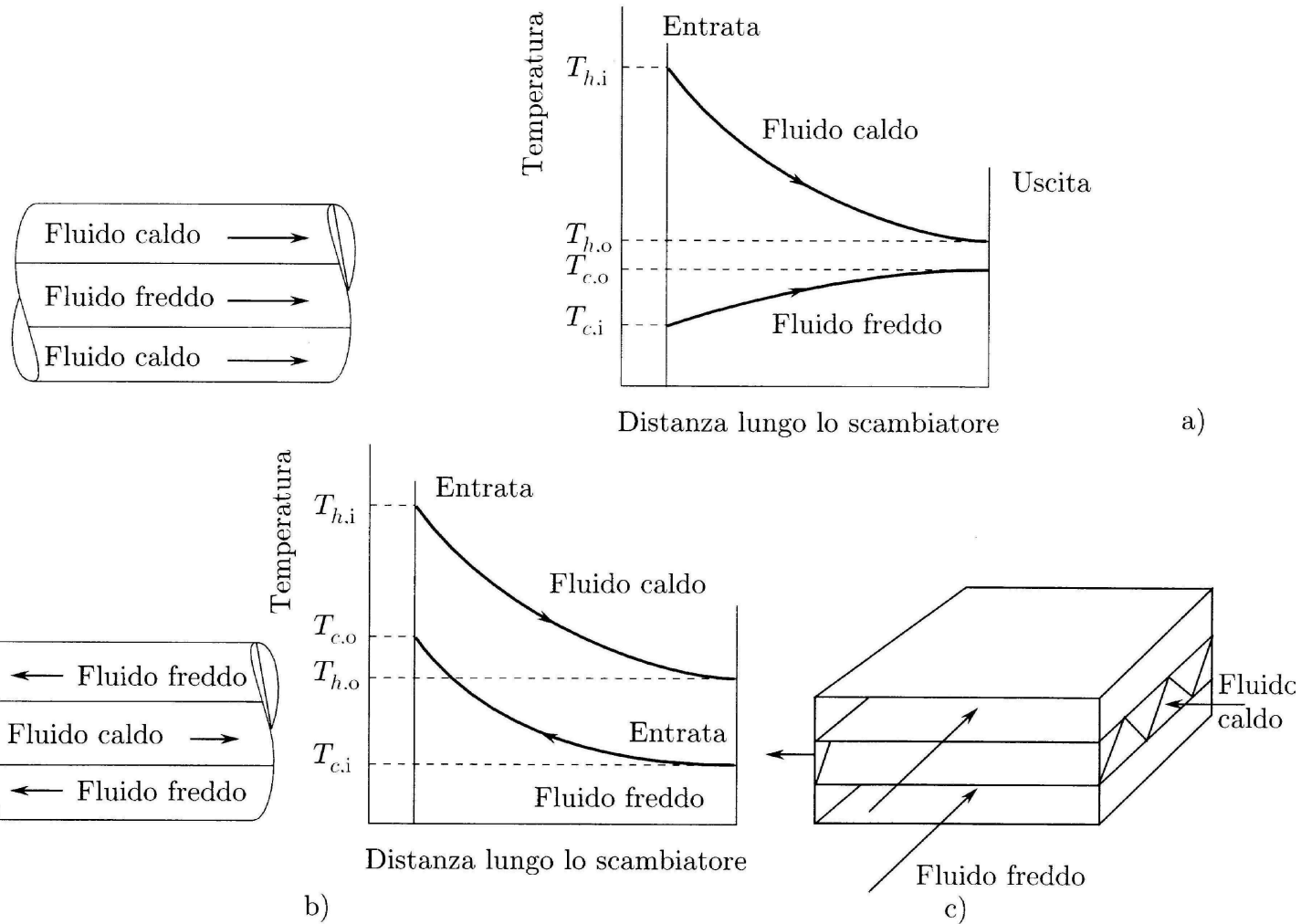

Configurazioni di moto nello scambiatore: a) correnti parallele equiverse, b) controcorrente, c) moto incrociato.

# Calcolo degli scambiatori

- $dQ = -\dot{m}_c c_{pc} dT_c = \pm \dot{m}_f c_{pf} dT_f = U(T_c - T_f) dA$

$$d(T_c - T_f) = -dQ \left( \frac{1}{\dot{m}_f c_{pf}} + \frac{1}{\dot{m}_c c_{pc}} \right)$$

$$d(T_c - T_f) = -U(T_c - T_f) \left( \frac{1}{\dot{m}_f c_{pf}} + \frac{1}{\dot{m}_c c_{pc}} \right) dA$$

$$\ln \frac{(T_c - T_f)_2}{(T_c - T_f)_1} = -UA \left( \frac{1}{\dot{m}_f c_{pf}} + \frac{1}{\dot{m}_c c_{pc}} \right)$$

# Calcolo degli scambiatori

$$Q = \dot{m}_f c_{pf} (T_{f2} - T_{f1}) = -\dot{m}_c c_{pc} (T_{c2} - T_{c1})$$

$$\ln \frac{(T_c - T_f)_2}{(T_c - T_f)_1} = -\frac{UA}{Q} [(T_c - T_f)_1 - (T_c - T_f)_2]$$

$$Q = UA \frac{\Delta T_2 - \Delta T_1}{\ln \left( \frac{\Delta T_2}{\Delta T_1} \right)} = UA \Delta T_m$$

$$\Delta T_1 = T_{c1} - T_{f1} \quad \text{e} \quad \Delta T_2 = T_{c2} - T_{f2}$$

# Scambiatori di calore

- Tipi principali
  - Shell and tube (Tubi e Mantello)
  - A piatti
  - Compatti

# Tubi e mantello

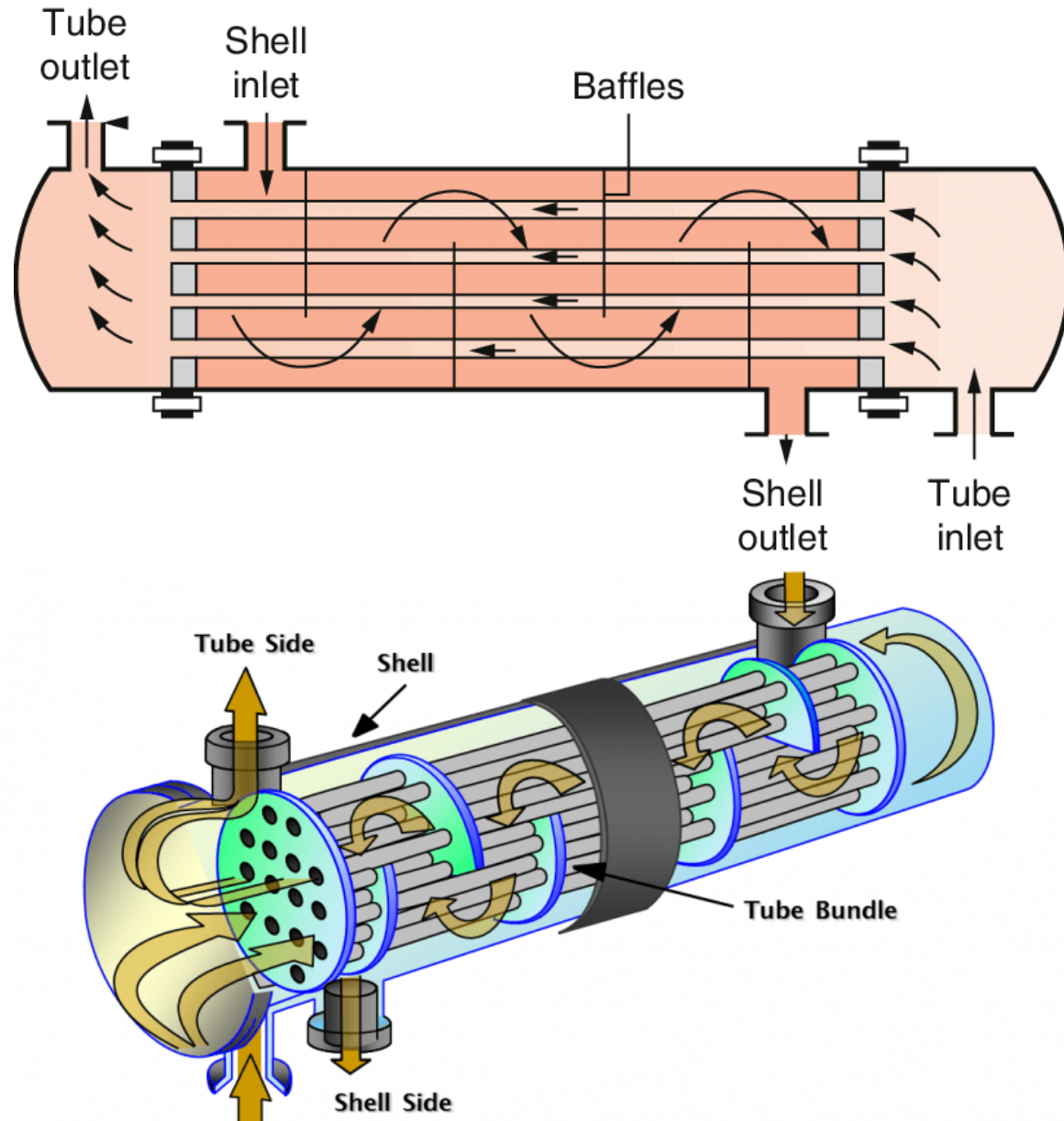

# Tubi e mantello





# Tubi e mantello

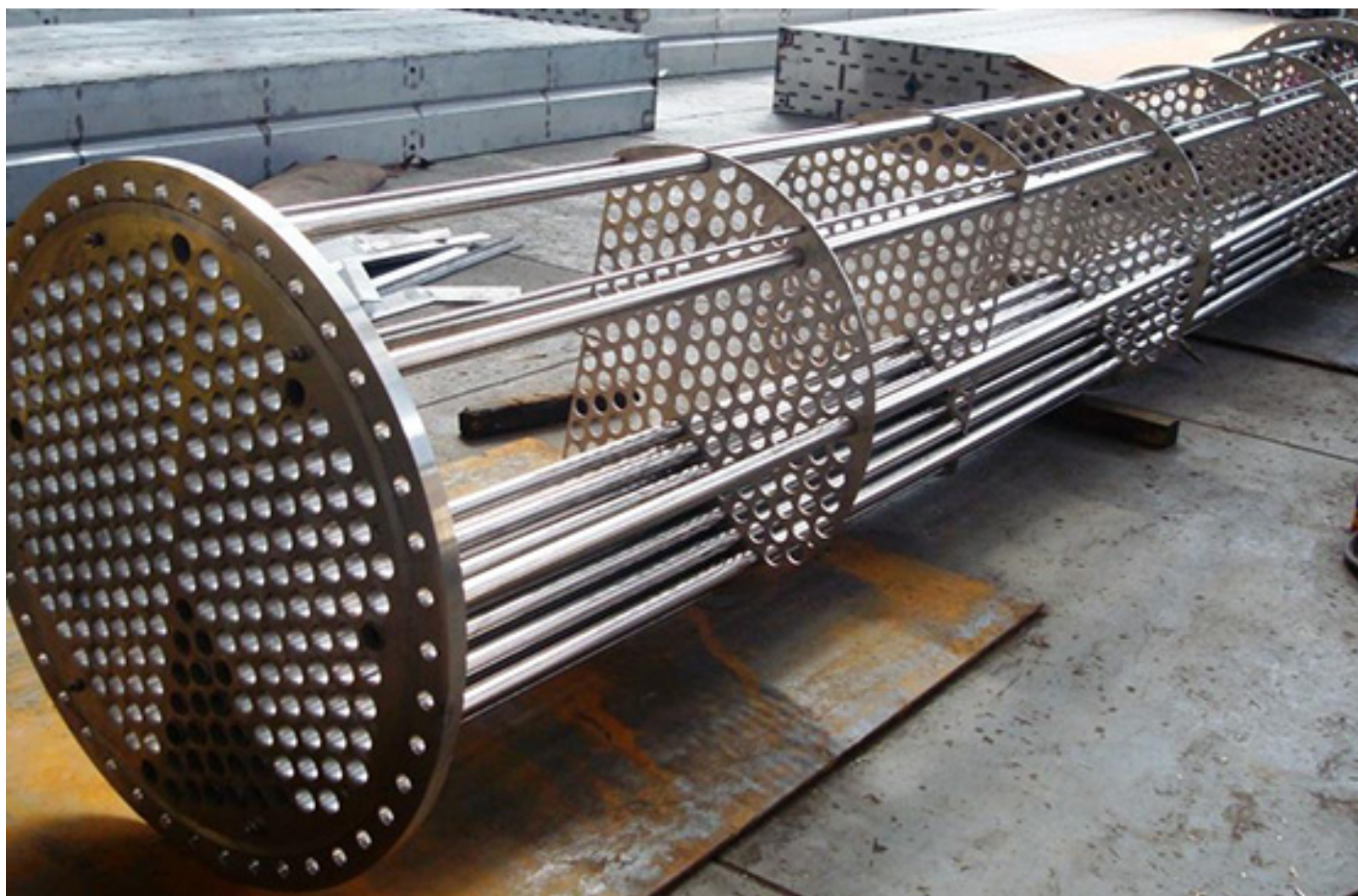

# Piatti

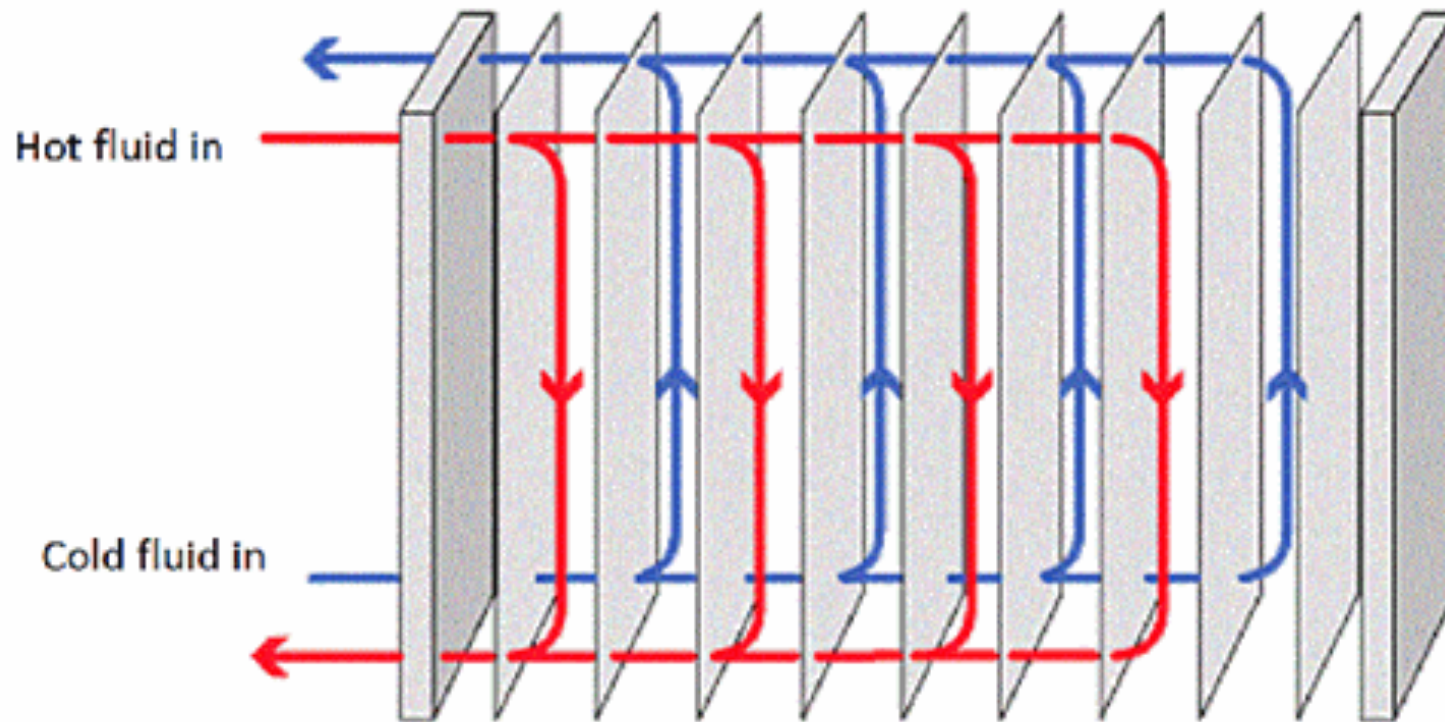

# Piatti

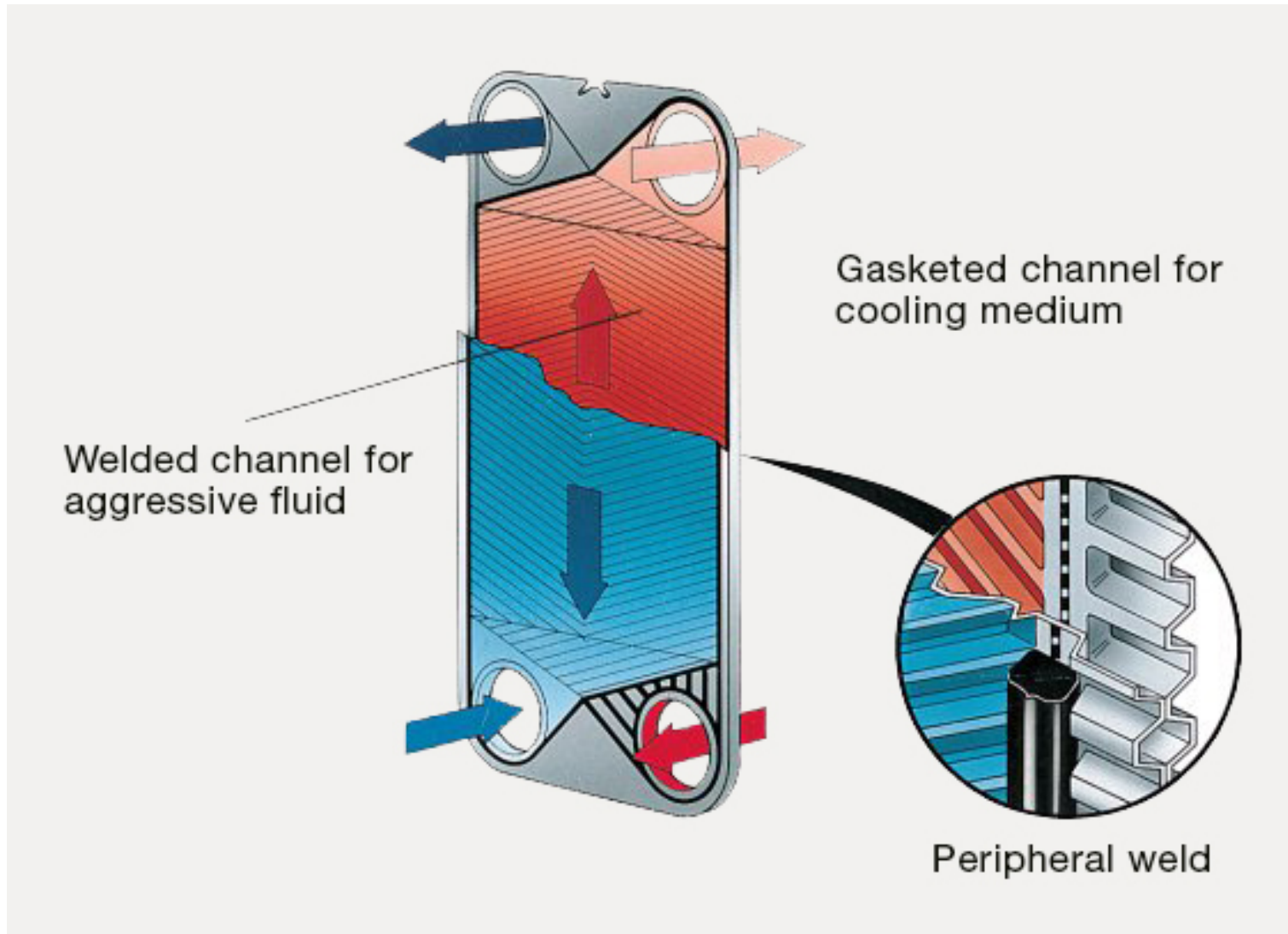

# Piatti



# Piatti

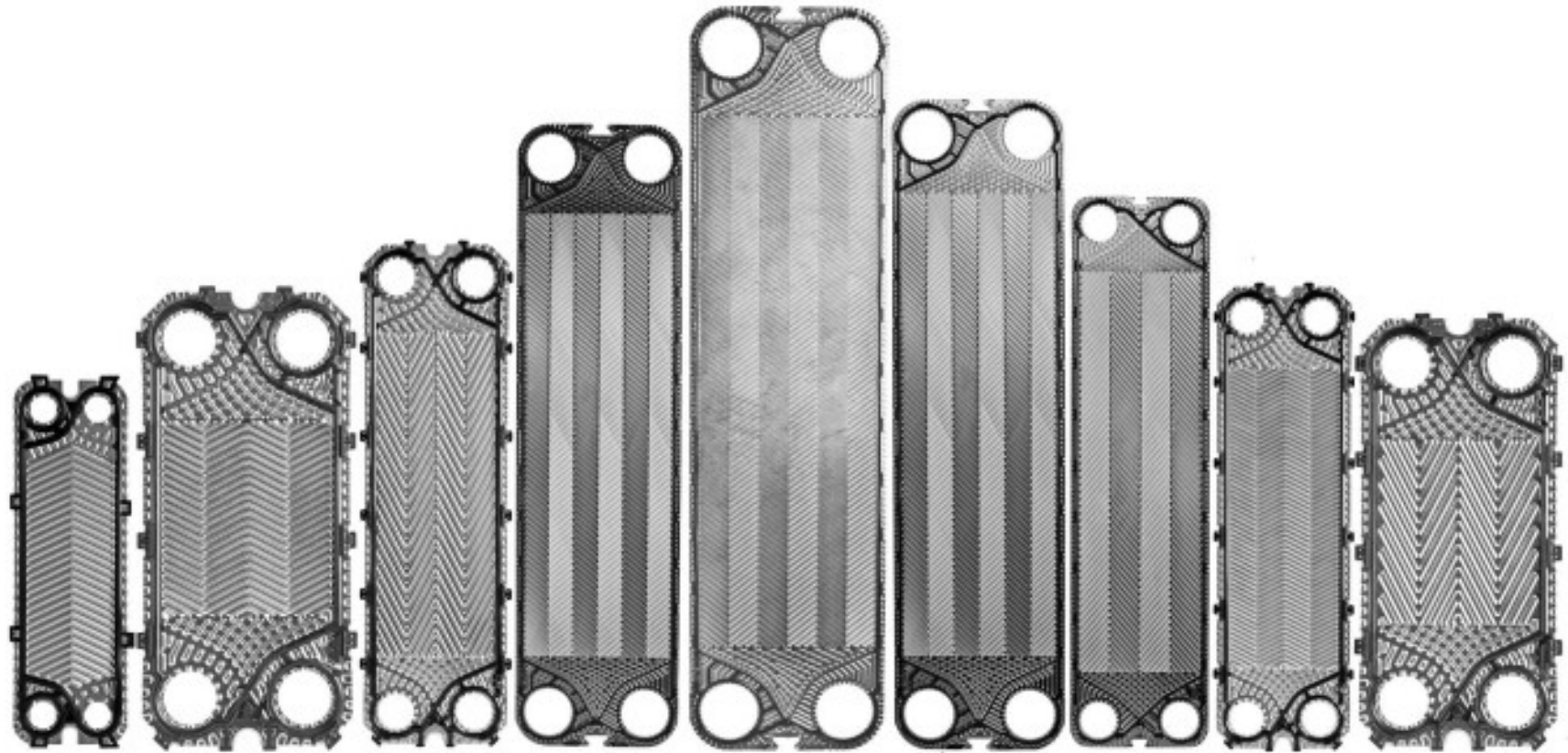

# Compatti

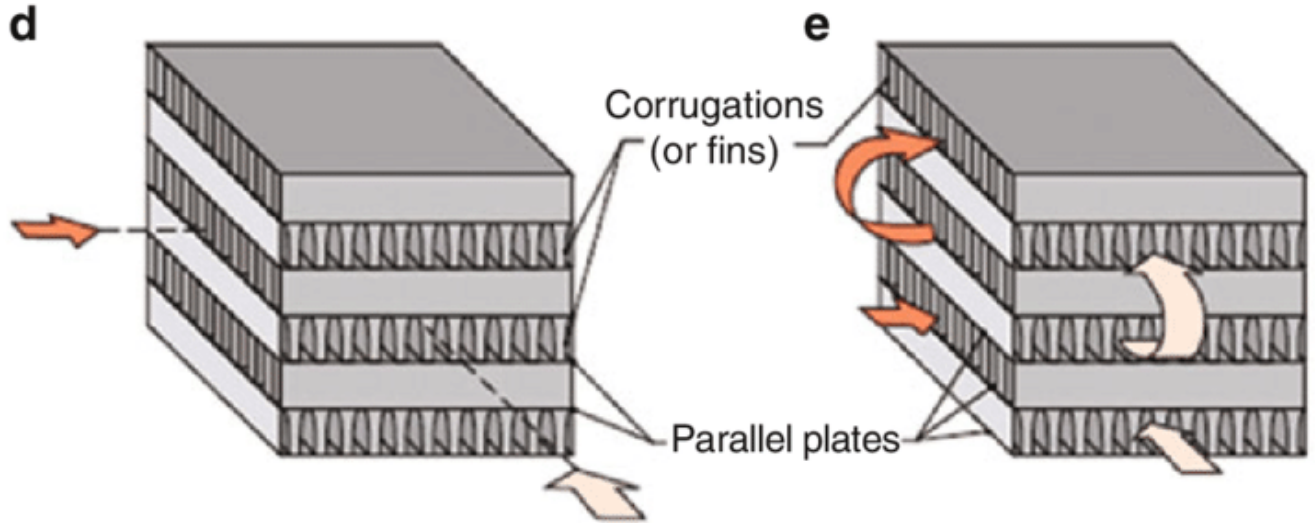
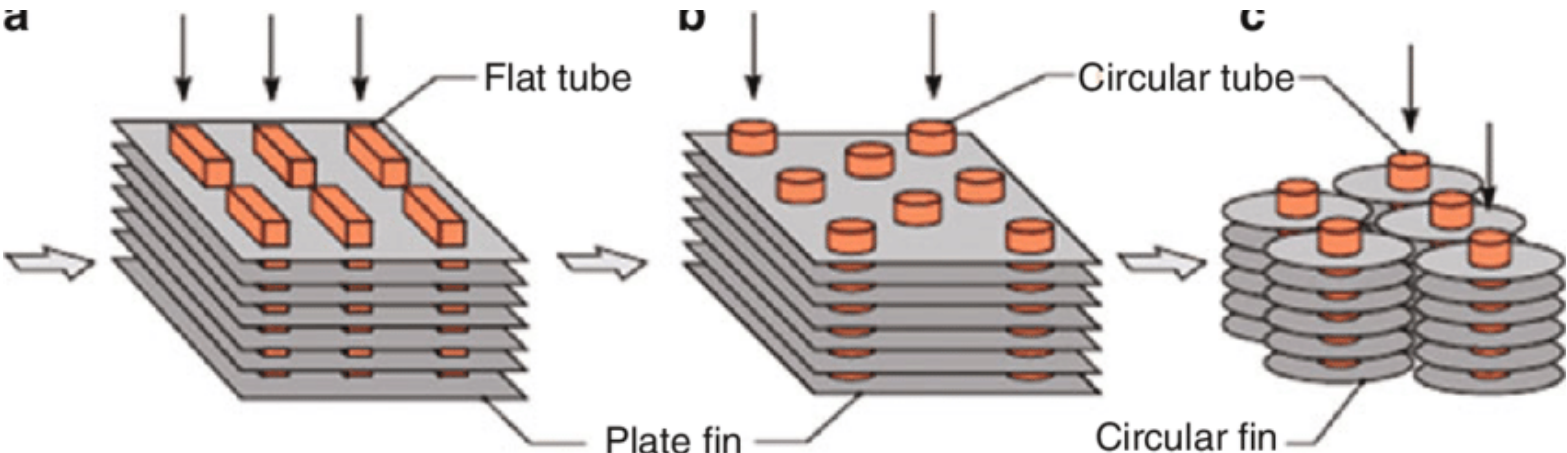

# Compatti

